

INDUSTRIAL MIXERS

OPTIMUM MIXING EFFECT FOR FOOD PRODUCTION

ME 500 N
ME 1000 N

ME 1000
ME 1500

ME 2000
ME 3000

ME 4500

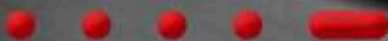

APPLICATIONS OF THE LASKA MIXERS

LASKA mixers are used for the precise mixing of meat and fat, as well as the gentle mixing in of chunks and/or ingredients into meat and other materials. Exact mixing is necessary to be able to produce consistent product quality. LASKA customers use mixers to produce:

- › **Boiled sausage**
- › **Minced meat and burgers**
- › **Raw sausage**
- › **Cooked sausage**
- › **Pies**
- › **Standardization of raw materials**
- › **Kneading of ham**
- › **Vegetable and salads**

STRENGTHS AND BENEFITS

The intermeshing mixing shafts ensure a much larger operating range than mixers with shafts arranged side by side. The low central web between the mixing shafts provides for good transverse mixing of the products. This demonstrably results in very fast and even mixing and gentle treatment of the mixture. Mixers are used for large quantities to be processed, mainly to standardize the raw materials. Feeding is effected either via feeding plants or via conveyor belts, worm conveyors, or pumps.

QUALITY PROVEN IN USE

Just like all other LASKA machines, the mixers are made of solid stainless materials. They meet strict hygienic requirements and are easy to clean. The design allows for unusual operating conditions and provides easy and safe operation as well as good access for servicing.



LASKA MIXERS

YOUR BENEFITS AT A GLANCE

PRODUCTION

- › Gentle mixing in, exact and fast distribution of pieces of meat and ingredients
- › Ideal, even mixing at consistent quality; also in the case of delicate mixtures which can be difficult to mix
- › No smearing caused by „overmixing“ of the mixture
- › Intermeshing paddle mixing shafts for the largest possible operating range (including hopper corners)
- › All models and sizes also available as vacuum version

HYGIENE AND SAFETY

- › Special double sealing system of the mixing shafts with cleaning ducts for perfectly hygienic cleaning
- › Polished surfaces for highest possible hygienic standard
- › Safety equipment for optimum working safety
- › Perfect access to mixing shafts and mixing hopper due to cleaning treads and/or platform



SERVICE AND MAINTENANCE

- › Minimum maintenance required due to proven, field-tested machine concept
- › Easily accessible inspection doors
- › Worldwide service network and support on all continents

OPERATION

- › Easy handling and user-friendly, robust operating elements
- › Optional automatic mixing to control speed, direction of rotation, and mixing time
- › Optional PMS Production Management System for automatic, recipe-controlled mode of operation

ELECTRICAL EQUIPMENT

- › Low current consumption due to state-of-the-art drive and control technology
- › Infinitely variable feed worm
- › Programmable logic controller with microprocessors in many user languages

DESIGN

- › Compact and space-saving design with integral control cabinet
- › Long service life
- › Low operating noise
- › Attractive, elegant design

MACHINE TYPES

THE VERSATILE LASKA PRODUCT RANGE



FEATURES

TILTABLE MIXER

ME 500 - 1000 N

- › Hopper size: 500 / 1000 litres
- › With 2 paddle shafts, or optionally with Z-mixing arms



FEATURES

MIXER WITH SIDE DISCHARGE

ME 1000 - 4500

- › Hopper size: 1000 - 4500 litres
- › Unloading flap provided with safety cover and trolley safety check
- › Cleaning platform for better access



APPLICATION

TILTABLE MIXING MACHINE

ME 500 - 1000 N

- › For tough and/or dense products
- › Unloading at the push of a button by tilting the mixing hopper
- › Shortest unloading time due to tilting the mixing hopper and actuation of the mixing shafts (two-hand control)



APPLICATION

MIXER WITH SIDE DISCHARGE

ME 1000 - 4500

- › For standardization
- › Unloading is effected via a large unloading flap into a standard tote bin/trolley
- › With 2 paddle mixing shafts and/or 1 paddle and 1 spiral mixing shaft as an option



EQUIPMENT FOR YOUR TILTABLE LASKA MIXER

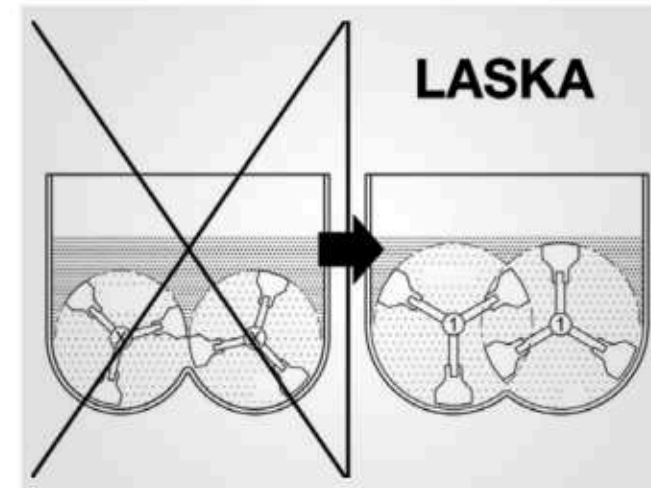

INTERMESHING PADDLE MIXING SHAFTS

- › Short mixing time and even mixing
- › Large effective operating range due to large diameter of the mixing shafts

INFINITELY VARIABLE SPEED OF MIXING SHAFTS

- › Particularly gentle mixing of the material
- › Perfect adaptation of mixing shaft speed to the respective mixture
- › Prevents overmixing of the mixture



UNLOADING

- › Shortest unloading time due to tilting of the mixing hopper (compared with mixing machines with lateral unloading flaps)
- › Excellent unloading of the mixture even in case of very compact products

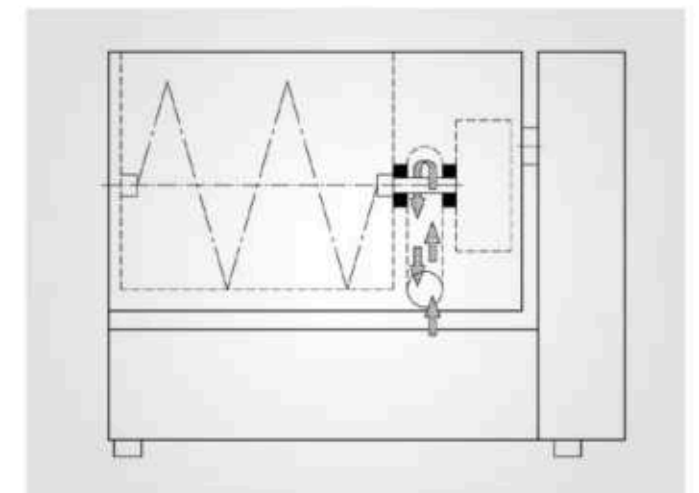

HYGIENE

- › Double sealing of mixing shafts between product and drive areas
- › Product area is reliably protected against the penetration of bearing lubricants and/or gear oils
- › Drive areas are reliably protected against the penetration of product residues
- › Cleaning ducts for perfectly hygienic cleaning

EQUIPMENT

FOR YOUR LASKA MIXER WITH SIDE DISCHARGE

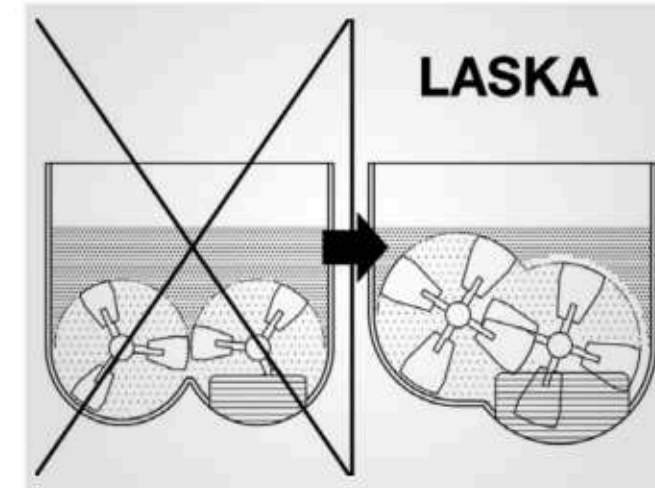

INTERMESHING PADDLE MIXING SHAFTS

- › Short mixing time and even mixing
- › Large effective operating range due to large diameter of the mixing shafts
- › Short unloading time due to large unloading flap
- › Unloading flap located in the deepest area of the mixing hopper, thus permitting perfect and quick unloading

INFINITELY VARIABLE SPEED OF MIXING SHAFTS

- › Particularly gentle mixing of the material
- › Perfect adaptation of mixing shaft speed to the respective mixture
- › Prevents overmixing of the mixture

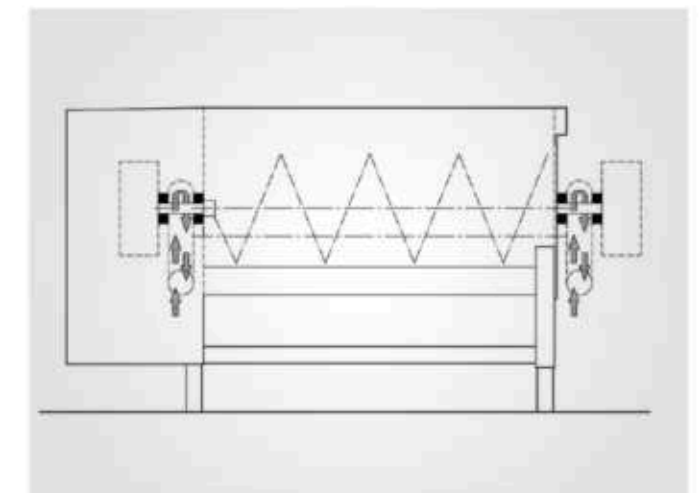

UNLOADING

- › At the push of a button via a large unloading flap opening pneumatically
- › Special design of the flap ensures fast unloading
- › Flap can be actuated only if safety cover is closed

HYGIENE

- › Double sealing of mixing shafts between product and drive areas
- › Product area is reliably protected against the penetration of bearing lubricants and/or gear oils
- › Drive areas are reliably protected against the penetration of product residues
- › Cleaning ducts for perfectly hygienic cleaning



OPTIONS FOR YOUR LASKA MIXER

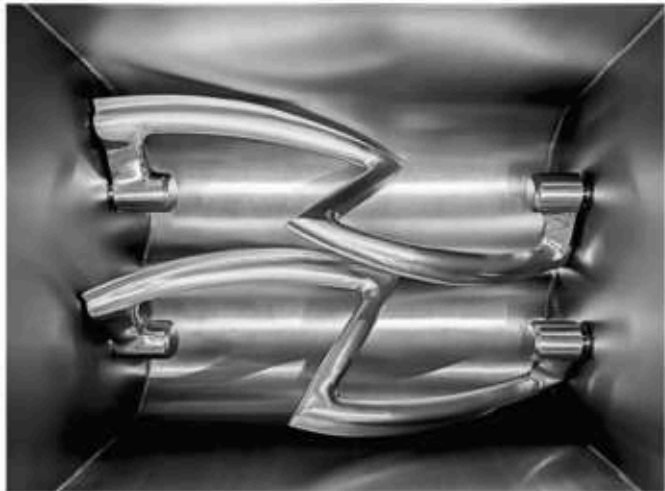

Z-SHAPED MIXING ARMS ME 500 - 1000 N

- › Ideal design for tough products that are to be kneaded
- › Perfect for mixing in of fillings in meat as well as for fluid products
- › Ideal for frequent product changes
- › Especially easy to clean
- › Complete unloading



PADDLE AND SPIRAL MIXING SHAFTS ME 1000 - 4500

- › Ideal for standardization of products
- › Provided with large, inclined paddles
- › Additional spiral shaft for particularly efficient mixing



VACUUM VERSION

- › Little air entrapped, therefore longer shelf life of products
- › For quality and taste improvement
- › For nice, flesh-coloured, and compact sausage meat
- › Intensive, even reddening
- › Fresh and attractive appearance



CO₂ OR NITROGEN (N₂) COOLING

- › Via cover or bottom nozzles for various applications
- › Automatic temperature control due to temperature sensor
- › Stainless mixing hopper lid, actuated hydraulically or pneumatically
- › Suction flange

OPTIONS FOR YOUR LASKA MIXER

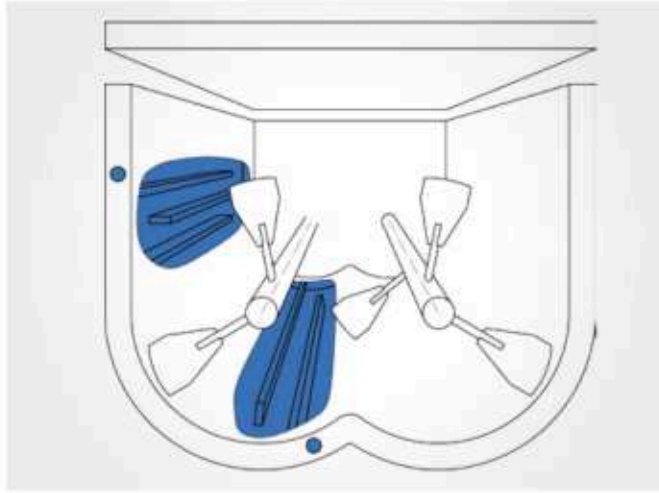

COOKING AND/OR COOLING FACILITY VIA CLOSED STEAM OR COOLING CIRCUIT

- › Closed steam or cooling system due to double jacket of mixing hopper
- › Stainless mixing hopper lid
- › Automatic temperature control
- › Electric control

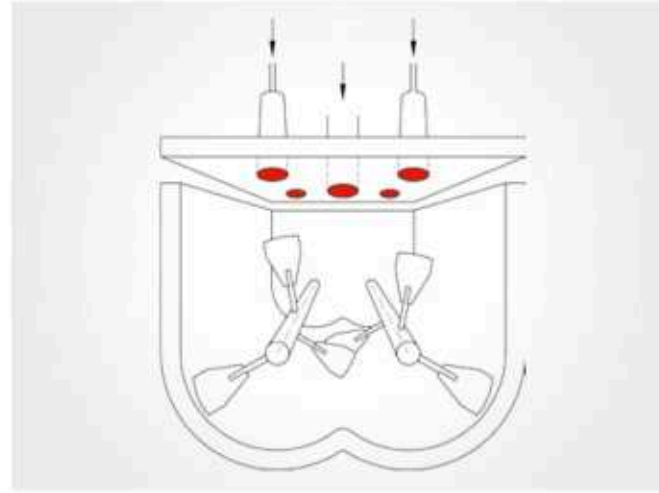

HEATING AND COOKING FACILITY VIA DIRECT STEAM INJECTION

- › Direct steam injection into the mixing hopper
- › Stainless mixing hopper lid
- › Automatic temperature control
- › Electric control

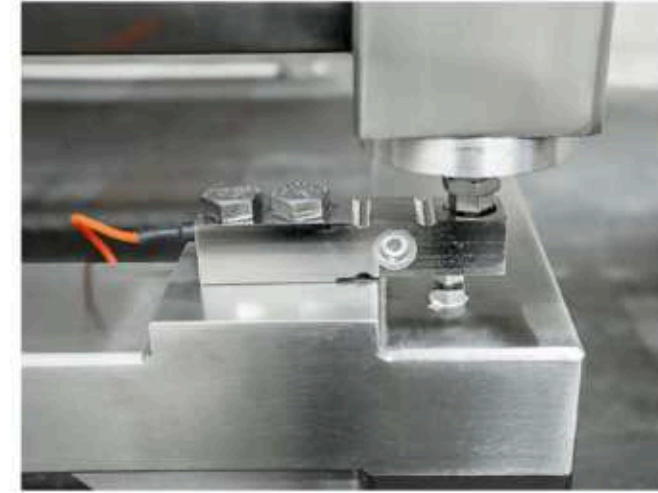

WEIGHING EQUIPMENT

- › Various versions depending on application and requirement
- › Display of the weights of mixed quantities, added quantities, removed quantities
- › Automatic starting and stopping of loading and unloading processes possible

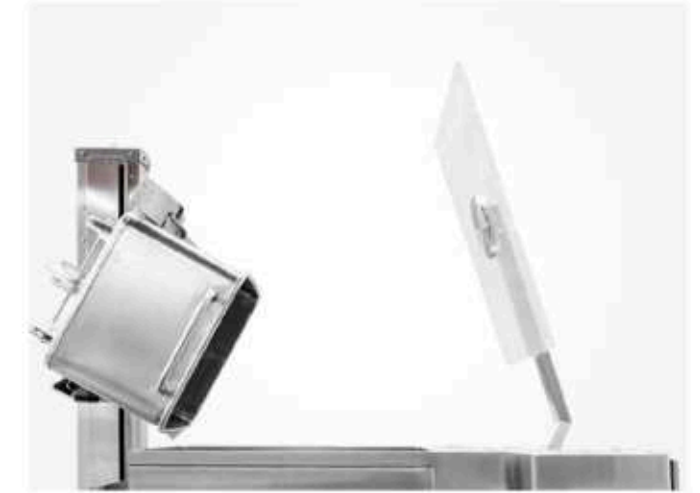

HYDRAULIC LOADING HOIST FOR 200 LITRE STANDARD TRANSPORT TROLLEY

- › Stainless, hydraulic
- › Easy to operate
- › Robust, low-maintenance, and durable due to hydraulic drive



PMS MIXING PROCESS CONTROL SYSTEMS

- › Freely programmable, automatic work sequence
- › Creation, storage and automation of recipes and production lists
- › Presetting of speed and time of mixing shaft rotating direction (forward, reverse, pause)
- › Programming of machine options
- › Up to 999 programmes depending on customer requirement



WATER DOSING

- › Automatic addition of freely selectable amount of water
- › Can be preselected and called during production at the push of a button
- › Other liquids than water up to +90 °C can be added





THAT'S WHAT OUR CUSTOMERS SAY ABOUT THEIR LASKA MIXER



KERRY FOODS
IRELAND

„We are very pleased with our decision to purchase LASKA ME 3000 Mixing Machines. LASKA's quality of design, build and their ability to supply us with a turn-key solution was a key factor in our final decision. These machines offer us more flexibility to process our products.“

We have worked with LASKA for many decades and they understand our needs in this very competitive market place.“

MR. PHELAN
PROJECT MANAGER



**LIEBHART HOLDING GMBH
& CO. KG**
GERMANY

„As early as 1980 we started with a LASKA mixer producing fruit preparations. Currently, we use 9 mixers of various sizes.“

To us, the main advantages are the excellent mixing result, the solid and robust workmanship, the technical handling of the operating equipment, as well as easy cleaning. Last but not least, we also appreciate the excellent customer service just in case that a malfunction should occur, and very good availability for questions and ordering.“

MR. LIEBHART
MANAGING DIRECTOR
AND TECHNICAL MANAGER



**ÖZTAS FLEISCHHANDEL
& DÖNERPRODUKTION EK**
GERMANY

„LASKA enjoys our full confidence. Our mixer runs almost without trouble and maintenance, and better and/or more efficient than other mixers we tested with our products. What we find particularly intriguing is the cleaning procedure, which works extraordinarily well.“

To us, LASKA is not only a reputable contact partner, but they also give us production safety due to their long experience with the construction of mixers.“

MR. ÖZTAS
MANAGING DIRECTOR

TECHNICAL DATA

PERFORMANCE LIST

PERFORMANCE CHARACTERISTICS								
TYPE		ME 500 N	ME 1000 N	ME 1000	ME 1500	ME 2000	ME 3000	ME 4500
Mixing hopper	ltr	500	1000	1000	1500	2000	3000	4500
Max. filling quantity	kg	400	800	800	1200	1600	2400	3600
Unloading		tiltable	tiltable	lat. flap	lat. flap	lat. flap	lat. flap	lat. flap
Motor rating	kW	7,5	11 o 15	7,5 o 11	11 o 15	15 o 22	22 o 30	30 o 45
Fuse	A	25	35	25	35	50	63	100
Feed pipe cross section	mm ² CU	4	6	4	6	10	16	35
Intermeshing mixing shafts - standard		2 paddles	2 paddles	2 paddles	2 paddles	2 paddles	2 paddles	2 paddles
Intermeshing mixing shafts - option		2 Z-arms	2 Z-arms	1 paddle 1 spiral	1 paddle 1 spiral	1 paddle 1 spiral	1 paddle 1 spiral	1 paddle 1 spiral
Infinitely variable speed of mixing shafts	rpm	35	30	29	29	25	25	20
Vacuum version		o	o	o	o	o	o	o
Suction capacity vacuum pump	m ³ /h	63	160	160	250	250	250	400
Safety switching strip mixing hopper		– not required ¹	o CE	o CE	o CE	o CE	o CE	o CE
CO ₂ or nitrogen (N ₂) cooling		o	o	o	o	o	o	o
Cooking and/or cooling facility (closed system)		o	o	o	o	o	o	o
Heating and cooling facility (direct steam injection)		o	o	o	o	o	o	o
Machine elevation		–	–	o	o	o	o	o
Water dosing		o	o	o	o	o	o	o
Weighing equipment		o	o	o	o	o	o	o
Temperature display		o	o	o	o	o	o	o
Loading mast/hoist		o	o	o	o	o	o	o
Conveyor belt charging		–	o	o	o	o	o	o

CAPTION

•	standard	1	equipped with safety cover (CE compliant)
o	option		
–	not available		

DIMENSIONS AND WEIGHT

TYPE		ME 500 N	ME 1000 N	ME 1000	ME 1500	ME 2000	ME 3000	ME 4500
	Length mm X	2010	2890	2480	3100	3100	3810	3680
	Width mm Y	1120	1180	1950	1950	2220	2220	2580
	Height mm Z	1650	2300	2070	2070	2270	2270	2650
	Height incl. hopper lid (opened) mm A	2850	3650	3200	3200	3650	3050	3400
	Height incl. feeding mm B	2600	3100	2950	2950	3100	3100	3400
	Weight kg	1500	2700	2200	2600	3200	3500	4200

SEAWORTHY CASE*

	Length mm	2350	2900	2700	3300	3300	4000	3900
	Width mm	1600	1600	1700	1700	1900	1900	2300
	Height mm	1900	2500	2200	2200	2300	2300	2400
	Weight kg	400	550	500	600	700	850	1000

* depending on type of transport

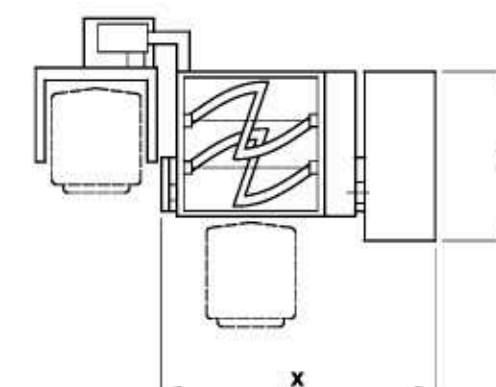
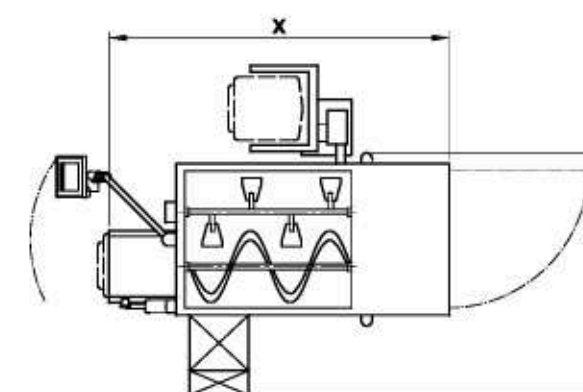
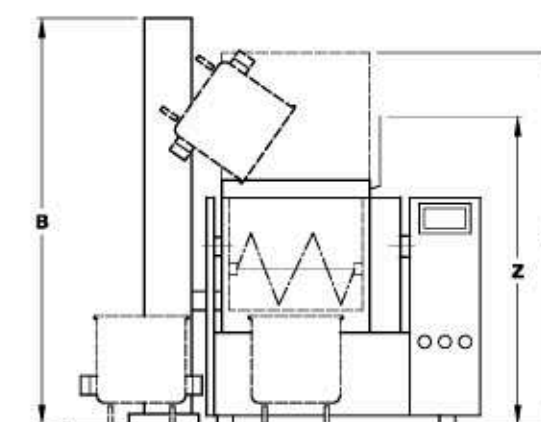
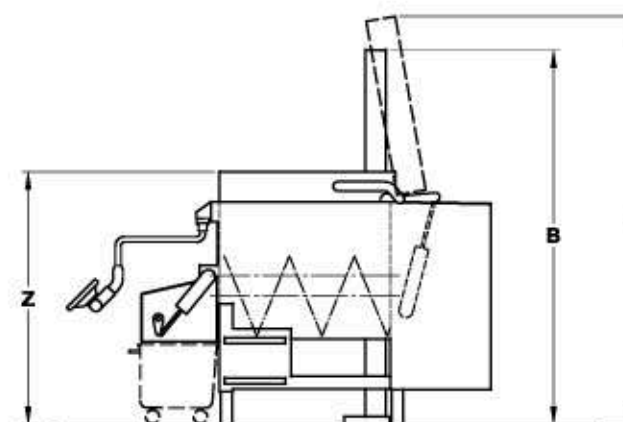

TRADITION & INNOVATION MORE THAN 130 YEARS OF EXPERIENCE



Since 1880, the family enterprise has been active as a supplier of the food industry and closely associated with the latter. The machines produced by LASKA are high-grade products made of stainless steel featuring a number of auxiliary equipment.

Although LASKA is generally known for the best processing of meat, there are numerous other applications in practice, such as the processing of grease, cheese, fruit, vegetable, yeast, pasta, sweets, etc.

Today, LASKA machines are famous for their high quality in more than 130 countries on all continents, where they work to the complete satisfaction of national and international customers.

OUR PRODUCT RANGE:

- Cutters
- Grinders
- Frozen meat cutters
- Emulsifiers
- Mixing machines
- Production lines



Maschinenfabrik LASKA Gesellschaft m.b.H.

Makartstraße 60, 4060 Traun – Austria

P +43 7229 / 606-0

F +43 7229 / 606-400

laska@laska.at

www.laska.at

DEALER/PARTNER

